

HORIBA

2D Infrared Thermometer

 **ii-1064**

CODE : I1001129000

Operating Manual

To ensure proper usage of this instrument, please make sure to read this manual thoroughly prior to use. After having read it through, make sure to keep it in a safe place for quick reference.

Unauthorized reprinting or reproduction of this manual in whole or in part is strictly forbidden without the expressed permission of Horiba, Ltd.

© Copyright HORIBA Ltd. 2002

Printed in Japan

Before starting

We would like to take this opportunity to express our deepest thanks and appreciation for having purchased this ii-1064 2D Infrared Thermometer. This operating manual is intended for this instrument's users. To ensure proper and safe handling, please read this book through prior to use.

Liability

Please acknowledge that the manufacturer is not liable for any loss of data due to breakage, mishandling, or malfunction nor for any damage, whether direct or incidental, resulting from improper usage by the owner or by a third party.

Conformable Directive

This equipment conforms to the following directives and standards;
Directives : The EMC Directives 89/336/EEC as amended by 91/263/EEC, 92/31/EEC and 93/68/EEC, in accordance with Article 10 (1) of the Directive.
Standards : EN61326:1997/A1:1998 Class B
Minimum requirements



FCC rules

Warning : This equipment has been tested and found to comply with the limits for a Class A digital device, pursuant to Part 15 of the **FCC Rules**. These limits are designed to provide reasonable protection against harmful interference when the equipment is operated in a commercial environment. This equipment generates, uses, and can radiate radio frequency energy and, if not installed and used in accordance with the instruction manual, may cause harmful interference to radio communications. Operation of this equipment in a residential area is likely to cause harmful interference in which case the user will be required to correct the interference at his own expense.

Trademarks and registered trademarks

"Internet Explorer" and "Excel" are product names of Microsoft, USA. Other company or product names published in this manual are trademarks or registered trademarks of those companies.

Warning messages

Warning types and meanings

For safe and proper handling of this instrument, there are warning labels calling your attention on the unit itself. Also, in this manual, warning messages are printed in the following manner. Understanding well the contents of these messages is the key to safety.

WARNING

This indicates a potentially hazardous situation which, if not avoided, could result in death or serious injury.

CAUTION

This indicates a potentially hazardous situation which, if not avoided, may result in minor or moderate injury. It may also be used to alert against unsafe practices.

NOTE

Take note of the message that follows during operation.

Precautions

Ignoring the following precautions may result in damage or malfunction.

■ Precautions for use

- Do not let the unit come into contact with the measurement object.
- Do not drop the unit or expose it to strong shocks.
- Do not touch the lenses with something hard, apply force or pressure to the lenses, nor put foreign substances on the lenses.
- Do not let the unit get close to anything electrically charged.
- If the set emissivity differs from the measurement object one, measurement result will be incorrect.
- Do not wet the unit. This may cause damage the unit.

■ Precautions for usage environment

- Do not use or store the unit in direct sunlight, dusty areas, high temperature or humidity levels or in other corrosive surroundings.
- Do not use the unit near transceivers, wireless transmitters, or any other device that emits electromagnetic or radio waves.
- No condensation (Do not expose the unit to rapid change in temperature)
- Do not use the unit under environment with vibration.
- Dispose of the unit as a common industrial waste product.

Contents

Prior to use	2
Battery maintenance	4
Unit maintenance	6
Parts name and function	7
Measuring.....	15
Measurement area	18
Recording data.....	19
Viewing recorded images.....	21
Initial settings.....	22
Other settings.....	23
Trouble shooting	29
Specifications	30
Options.....	31

Prior to use

Prepare the unit prior to use as follows.

1 Attach the strap

Install the strap to reduce the risk of drops.

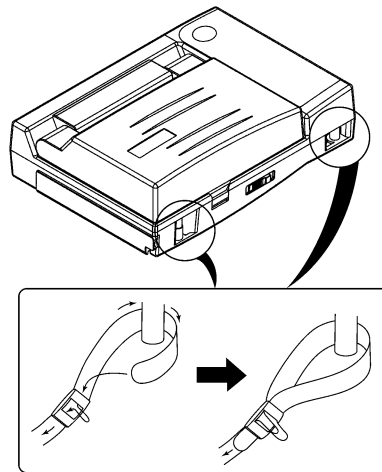

2 Load batteries

Load batteries correctly in the battery case on the bottom of the unit.
(Refer to "Battery maintenance" on P. 4.)

3 Set the clock

Set the clock and calendar according to the following steps (Refer to "Clock" on P. 25.):

1. Press the MENU button.
2. Select "CLOCK" with the cursor button.
3. Press the ENTER button to go to the clock-setting mode.
4. Use the cursor button to set the data and time.
5. Press the ESC button. This concludes the clock setting.

4 Initial setting

Set the displayed temperature unit (°C or °F) and the video output format (NTSC or PAL) according to the circumstances. Once these settings have been entered, they are saved as default settings even after next battery replacement.
(Refer to "Initial setting" on P. 22.)

5 Insert a CF card

Open the flap on the side of the unit and insert a CF card in the proper direction all the way inside.

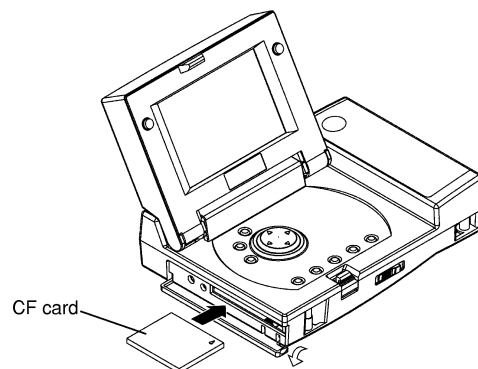

*CF card: compact flash card

It can save and store image data as well as transfer them to a computer or PDA without the use of special software.
Image: JPEG format Measured values: CSV format
A 8 to 128 MB CF card may be used.

Battery maintenance

CAUTION

- Batteries are not loaded in the unit when purchased. Set batteries as shown in the diagram below.
- Batteries included with shipment are for monitor use, their lifespan is not guaranteed.
- Manganese batteries may not be used. Use only alkaline or nickel-metal-hydride batteries.

Loading the batteries

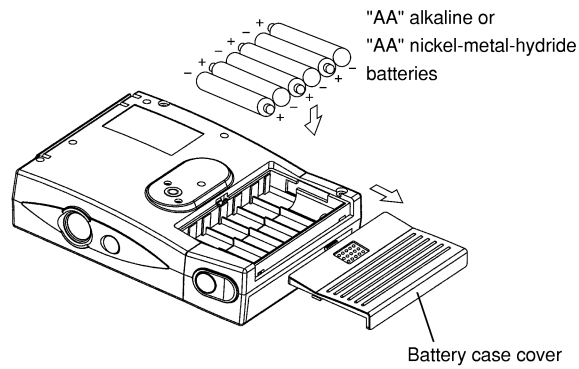

⚠ WARNING

- To recharge nickel-metal-hydrate batteries, use a proper battery charger. Improper recharge may result in battery explosion.
- Do not attempt at incinerating the batteries when disposing of them. This may also cause an explosion.

⚠ CAUTION

- After battery replacement, make sure to reset the clock. (Refer to "Clock" on P. 25.)
- Used batteries should be brought back to the store of purchase or taken to a battery disposal area.
- If you do not use the unit for a long time, remove the batteries from the unit.

Replacing the batteries**■ Battery indicator**

A battery indicator is displayed in LCD showing three energy levels remaining in the batteries. When the indicator displays only one bar or level, replace the batteries immediately.

Proper operations cannot be guaranteed when the indicator displays only one bar ("Replace").



Five minutes after the battery indicator displays only one bar ("Replace"), the unit will automatically shut itself off.

Unit maintenance

Lenses

CAUTION

The lenses are the most essential parts of the unit for accurate temperature measurement. The accumulation of dirt on the lenses results in accuracy in measurement and causes deterioration of the lenses.

When lenses are dirty

Remove dust from the lenses with a blower used for camera cleaning. Wipe off drops of water using gauze or a cotton swab. In the event of excessive dirt on the lenses, apply a small amount of isopropyl alcohol on a cotton swab and wipe the lenses clean with it.

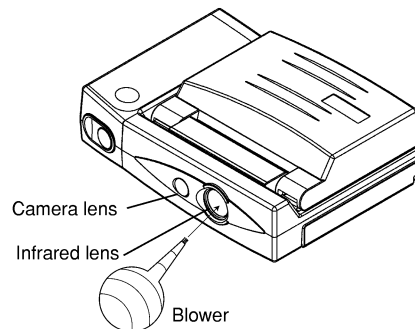

Cleaning the unit

Wipe the unit clean using a soft dry cloth. In the event the unit is excessively dirty, dip a cloth in diluted neutral cleanser, wring it well, and wipe the unit clean with it.

CAUTION

Do not use an organic solvent or other similar substance to clean the unit. This will cause damage to the unit's surface. Do not wash the unit with water. This will cause breakage of the unit.

Parts name and function

Top view

■ When closed the LCD screen

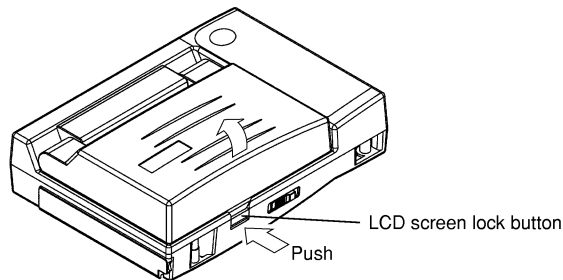

■ When opened the LCD screen

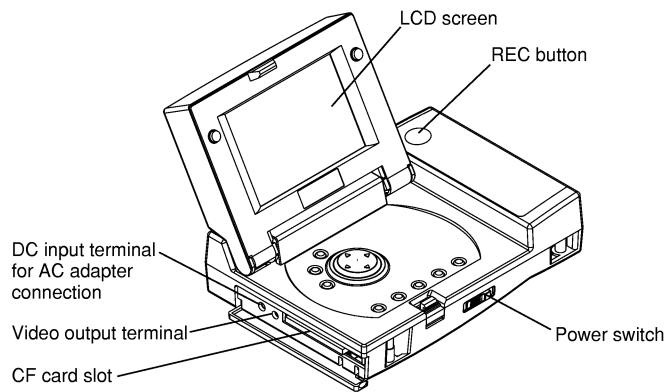

Front view

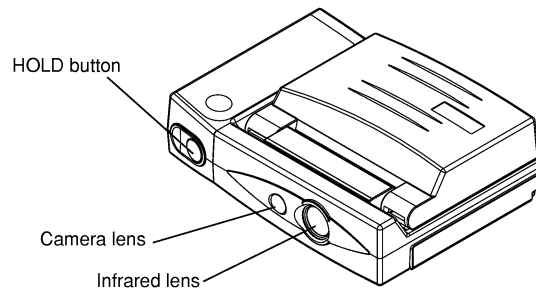

Bottom view

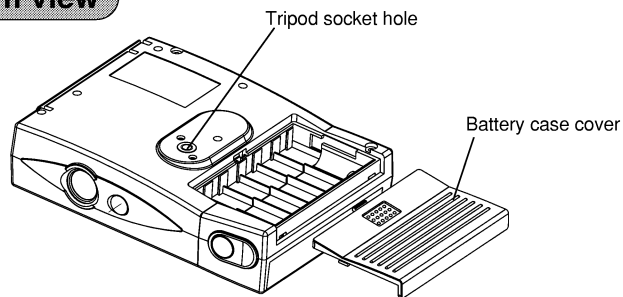

⚠ CAUTION

Connect only the dedicated AC adapter to the DC input terminal.

Video output terminal

The signal of the same image that appears on the LCD screen is outputted from the video output terminal.

To display the image on a TV monitor, connect the output terminal and the video input terminal of the monitor. Both the AC adapter and the video cable come in an option set sold separately.

Operation panel

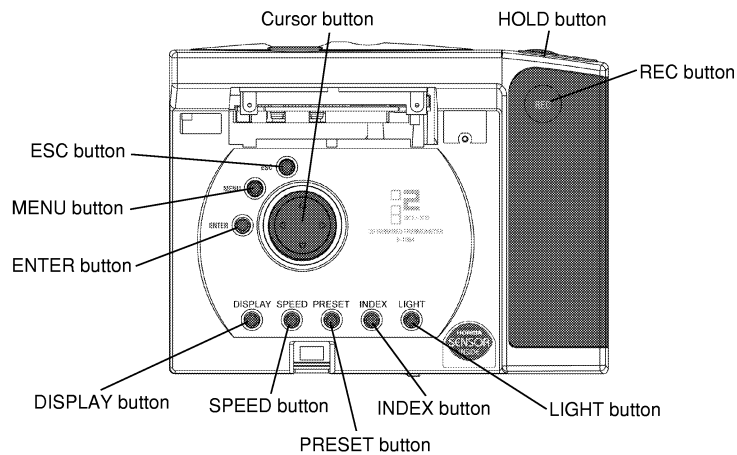

HOLD button

Switches the unit mode from measurement and hold.

REC button

Records the currently held data on the CF card.

ENTER button

Measurement mode: switches the parallax corrector (Refer to "Parallax" on P. 18.)
0.5 m→1 m→∞

Menu display mode: Enters the setting mode of the currently selected item.

Index display mode: Displays the currently selected image data full-screen.

MENU button

Measurement mode: Displays a menu of setting items.

ESC button

Menu display mode: Returns to the measurement mode.
Setting mode: Returns to the menu display mode.
Index display mode: Deletes the currently selected image data.

Cursor button

Measurement mode or hold mode:
Selects measurement points displayed as numerical values.
Index display mode: Selects the recorded data.
Menu display mode: Selects the settings.
Setting mode: Selects setting items or changes the setting values.

DISPLAY button

Switches the display modes. (Refer to "Select display mode" on P. 16.)

SPEED button

Switches the measurement speed between standard-speed (NORMAL) and high-speed mode (FAST).

NORMAL: Display resolution: 0.1 °C,
with moving average of 10 data (2 seconds)
FAST: Display resolution: 1 °C, no moving average

PRESET button

Switches the measurement conditions such as emissivity, scale, and warning settings. These measurement conditions are set in the setting mode.

INDEX button

Measurement mode: Enters the index display mode that shows thumbnails of recorded image data.
Index display mode: Return to the measurement mode.

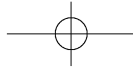

LIGHT button

Set the brightness of the LCD backlight. The default, immediately after switching on the power, is MIDDLE. If no operations are made for 10 seconds after setting the brightness to HIGHEST, the brightness will automatically return to MIDDLE. In automatic measurement, it will become LOWEST if no operations are made for 10 seconds.
If a battery indication displays only one bar ("Replace"), it's not possible to set HIGHEST.

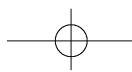
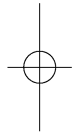

LCD

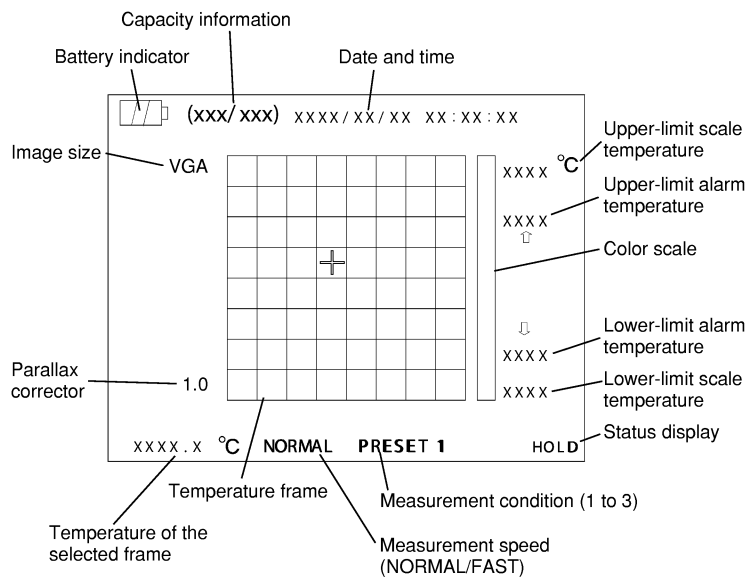

As illustrated above, data are arranged with the visible image as a base. The unit appears in this condition when in normal mode.

Color classification of the screen

Characters and numbers on the screen:

white

Display of the selected frame:

white cross

Battery indicator: white

Upper and lower limit alarm temperature marks:

white in normal condition

red in alarm condition (at the same time, the corresponding frame line thickens)

Battery indicator

The battery indicator displays 3 energy levels.

When  is displayed, replace the batteries immediately.

Capacity information

The numbers of recorded images and potential images calculated from the remaining capacity of the currently inserted CF card are displayed.

The potential number is a rough estimate and may differ from the actual depending on the data sizes of recorded images.

Date and time

Displays the built-in clock (updating every second).

Status display

Displays the operational status of the unit in normal mode.

MEAS (during measurement), HOLD (image hold), WAIT (stand-by for automatic measurement)

AUTO (during Automatic measurement)

Upper-limit scale temperature

Displays the upper-limit of measurement temperature set in the measurement condition.

Lower-limit scale temperature

Displays the lower measurement temperature set in the measurement condition.

Upper-limit alarm temperature

Displays the upper-limit alarm temperature set in the setting mode.

Lower-limit alarm temperature

Displays the lower-limit alarm temperature set in the setting mode.

Temperature of the selected frame

The selected frame is displayed with a white cross. The white cross may be moved in any direction with the cursor button. The temperature of the selected frame is displayed on the bottom left of the screen.

Temperature frame

Displayed according to the current display mode.

Measurement speed

Displays the selected response speed. The unit has two speeds, high-speed (FAST) and standard-speed (NORMAL).

Measurement condition

Displays the preset measurement condition number (1 to 3) selected in the measurement condition. (Refer to "Measurement conditions (PRESET)" on P. 23.)

Color scale

It is a color-coded temperature scale used for frame display or mosaic display. The color pattern may be selected from the following 3 patterns: rainbow, warm, and cool-color. (Refer to "Color scale" on P. 28.)

Parallax corrector

Displays the parallax corrector settings. (Refer to "Parallax" on P. 18.)

Image size

Displays the image size to be recorded on the CF card. (Refer to "Recorded image size" on P. 20.)

Measuring

About measurement

Use this unit alone

 (Refer to "Measuring" below.)

Use the HOLD button to hold or release the display screen. Use the REC button to save measurement results on the CF card.

Automatic measurement

Mount the unit on a tripod to perform automatic measurement at the same location. (Refer to "Automatic measurement" on P. 26.)

Video output

The same image as that displayed on the LCD screen may be displayed on a TV monitor, and can be recorded on a videotape.

Measuring

1 Power on

Open the LCD screen and slide the power switch to the right. After approximately ten seconds, the opening screen will be displayed. Following the opening screen (for ten seconds), a visible image, temperature data, etc. will be displayed.

Measurement screen example

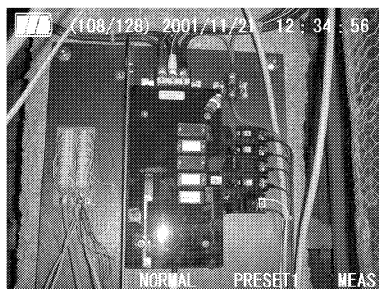

CAUTION

The screen display changes after the power on as follows:
Do not operate the power switch until a visible image appears on the screen.

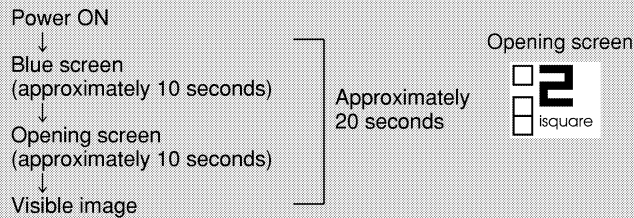

Operating the power switch before a visible image appears may disable the unit for startup. In this case, disconnect the AC adapter or remove the batteries for one minute and reset.

In power on of battery-use unit, if the screen light up for a moment but the opening screen does not appear after 10 seconds from that, replace the battery.

2 Select display mode

Select the display mode with the DISPLAY button.

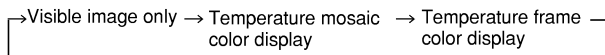

Color frame display example

Labels for the color frame display example:

- Battery indicator
- Capacity information (108/128)
- Date and time (2001/11/2)
- 12:34:56
- Upper-limit scale temperature (100°C)
- Upper-limit alarm temperature (80)
- Lower-limit alarm temperature (20)
- Lower-limit scale temperature (0°C)
- Status display (MEAS)
- Temperature of the selected frame (45.6°C)
- Measurement speed (NORMAL)
- Measurement condition (PRESET)

3 Measure

Point the lens toward the measurement object, and a corresponding visible image and temperature measurement result will be displayed.

Display mode: temperature frame color or mosaic color display with MEAS shown on the bottom right of the screen

Press the HOLD button to hold the display.

With HOLD show on the bottom right of the screen.

To record the data, press the REC button. (Refer to "Operation panel" on P. 9.)

Press the HOLD button again to release the hold, and instantaneous measurement results will be displayed.

The temperature of the measurement point selected with the cursor button is displayed on the bottom left of the screen.

NOTE

- To measure temperature accurately by adjust the distance as to keep the target frame and its perimeter within the range of the object.
- If the set emissivity value does not meet that of the object, accurate measurement results will not be obtained. (Refer to "Emissivity Chart" on P. 24 and "Settings" on P. 23.)
- In measurement of low-emissivity object, heat emission from a surrounding heat source may interfere that from the object to cause in accurate result.
In this case, avoid the heat source or put a shield between the source and object.

4 Power off

Slide the power switch to the right again, the unit will be power off. When the auto-power off setting be activated, the unit automatically power off if no operations are made for one minute.

Measurement area

The area of temperature measurement is illustrated below.
The dimensions used in the illustration are that for a 1 m distance between the unit and the object.

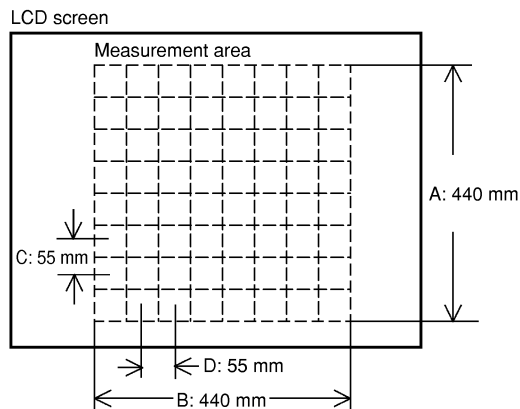

A, B: measurement area size (vertical and horizontal)
C, D: intervals between adjacent measurement point centers

Distance	A	B	C	D
0.5 m	220	220	28	28
1.0 m	440	440	55	55
2.0 m	880	880	110	110

(mm)

■ Parallax

The difference in position between the infrared lens and the visible lens may cause lateral displacement of the displayed area against measurement the actual measurement location.

This displacement is called "parallax." By aligning the parallax corrector with the object, the parallax can be reduced to a minimum. The parallax corrector may be set to three levels: 0.5 m, 1 m, and ∞ .

Recording data

■ When recording with the REC button

Press the REC button with the screen display held, both the currently displayed image and temperature data are stored on the CF card.

Stored file names

Image: PICTxxxx.jpg
Measurement values: DATAxxxx.csv

*"xxxx" is a serial number from 0001 to 9999, and automatically decided as follows.

When no data files are saved on the CF card, the number start with 0001, and increases by 1 every data storing. The next of 9999 is 0001.

The "xxxx" values of the corresponding image and temperature-value files are same. A temperature-value file contains 64 measurement point temperature data.

■ When recording data in automatic measurement

The displayed image and temperature data is recorded on the CF card. In automatic measurement, all the measured temperature data is recorded. However, the image recording depends on the SAVE DATA setting of auto mode conditions.

(Refer to "Automatic measurement mode" on P. 26.)

Stored file names

Image: PICTxxxx.jpg
Measurement values: LOGDATA.csv

*"xxxx" of a image file name is a serial number from 0001 to 9999, and automatically decided as follows.

When no data files are saved on the CF card, the number start with 0001, and increases by 1 every data storing. The next of 9999 is 0001.

Measurement value files are always named LOGDATA.csv. Even when multiple measurements are performed, each measurement value is saved in succession in one file (LOGDATA.csv). One measurement value contains 64 measurement point temperature data.

A commercially available CF card adapter may be used to manipulate the data on a personal computer. The image data can be viewed with browser software such as "Internet Explorer" and the temperature data can be read with "Excel." Data can be also copied or deleted with a personal computer.

■ Data in CSV files

The arrangement of recorded data in CSV files is as follows:

- 1st data: measurement date
- 2nd data: measurement time
- 3rd to 66th data: temperature values

Arrangement of data and measurement points

Upper of measurement area

3	4	5	6	7	8	9	10
11	12	13	14	15	16	17	18
19	20	21	22	23	24	25	26
27	28	29	30	31	32	33	34
35	36	37	38	39	40	41	42
43	44	45	46	47	48	49	50
51	52	53	54	55	56	57	58
59	60	61	62	63	64	65	66

Lower of measurement area

Left-side of measurement area

Right-side of measurement area

■ Recorded image size

Press the ESC button and the ENTER button simultaneously in measurement mode, the recorded image size is switched between VGA and QVGA. The VGA recorded image size is 640 x 480 dots and the QVGA size is 320 x 240 dots.

The frame rate of the LCD screen with VGA set is longer than that with QVGA set.

Viewing recorded images

Press the INDEX button to display thumbnails of recorded images. Select an image using the cursor button and press the ENTER button to enlarge the selected image. Press on the ESC button to return to the thumbnail screen.

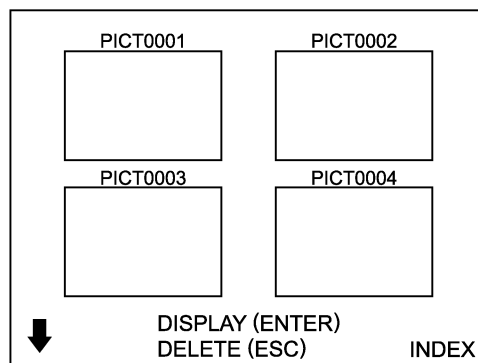

To delete an image, select the image and press the ESC button and then, press the ENTER button.
To return to the regular measurement screen, press either the DISPLAY button or the INDEX button.

NOTE

- When many (several dozens of) files are recorded, it may take considerable time to display all of them.

Initial settings

Power on the unit and press the DISPLAY button, PRESET button, and LIGHT button simultaneously, the screen will display the initial setting mode.

Initial setting screen



Select the settings with the vertical cursor buttons.
Change the settings with the horizontal cursor buttons.
The selected items are displayed in red.

- **Japanese/English**

This setting is invalid. The display is always in English.

- **NTSC/PAL**

NTSC: Sets the video output format to NTSC.

PAL: Sets the video output format to PAL.

- **°C/°F**

°C: Sets the temperature unit to Celsius.

°F: Sets the temperature unit to Fahrenheit.

To put the settings into effect, press the ESC button.

Other settings

Measurement conditions (PRESET)

Set measurement condition for PRESET 1 to 3.

The following items can be set:

- SCALE: Temperature range of the color scale
- ε : Emissivity correction value
- ALARM: Upper and lower alarm temperatures.
When the measured temperature is out of the range specified these values, a buzzer sounds. In frame color display, the frame line of the correspond point thickenes.

How to set

Enter the SETTING mode with the MENU button and select PRESET, and press the ENTER button.

Use the horizontal cursor buttons, to select the digit to be modified.

Use the vertical cursor buttons to adjust the value.

SETTING (PRESET)			
N ^o	SCALE	ε	ALARM
1	-30 ~ 200°C	1.00	150°C / -15°C
2	0 ~ 100°C	0.98	80°C / 15°C
3	-50 ~ 1000°C	1.00	900°C / -30°C

To establish the setting, press the ESC button.

To switch the presets, use the PRESET button.

<Default settings>

1 : SCALE	-50°C to 1000°C	ε	0.95	ALARM	-50°C / 1000°C
2 : SCALE	0°C to 50°C	ε	0.95	ALARM	0°C / 50°C
3 : SCALE	-30°C to 200°C	ε	0.95	ALARM	-30°C / 200°C

Scale range -50°C to 1000°C 1°C step (same for alarm setting)
Set ε range 0.10 to 1.00 0.01 step

Substances have own emissivity values.
To obtain proper temperature values, set the correct emissivity of the object to be measured.

■ Emissivity chart

In measurement for low emissivity objects, indicated values sometimes fluctuate. In this case, the use of blackbody spray or tape is recommended. Emissivity depends on the surface conditions and the thickness as well as the substance. Use the following examples in the chart as a reference.

Name		Name	Emissivity
Asphalt	0.90~0.98	Charcoal (powder)	0.96
Concrete	0.94	Paint lacquer	0.80~0.95
Cement	0.96	Paint lacquer (mat black)	0.97
Sand	0.90	Rubber (black)	0.94
Soil	0.92~0.96	Plastic	0.85~0.95
Water	0.92~0.96	Wood	0.90
Ice	0.96~0.98	Paper	0.70~0.94
Snow	0.83	Aluminum oxide	0.76
Glass	0.90~0.95	Chromium oxide	0.81
Ceramic	0.90~0.94	Copper oxide	0.78
Marble	0.94	Iron oxide	0.78~0.82
Fluorite	0.30~0.40	Nickel oxide	0.90
Gypsum	0.80~0.90	Titanium oxide	0.40~0.60
Plaster	0.89~0.91	Zinc oxide	0.11~0.28
Red brick	0.93~0.96	Brass oxide	0.56~0.64
Fiber	0.90	Uneven bronze	0.55
Cloth (black)	0.98	Rolled stainless	0.45
Skin (human)	0.98	Rusted steel	0.69
Leather	0.75~0.80		

Clock

Set date, time, and auto power-off function for the build-in clock.

■ How to set

Enter the setting mode with the MENU button, select the CLOCK setting and press the ENTER button. The screen for CLOCK setting will be displayed.

In this screen, the settings for the DATE/TIME, DISPLAY STYLE, and auto power-off function may be selected.

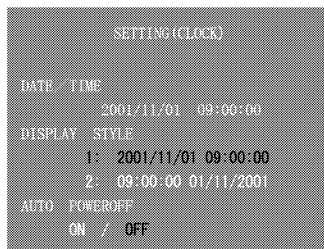

```
SETTING(CLOCK)

DATE / TIME      2001/11/01  09:00:00
DISPLAY STYLE
  1: 2001/11/01 09:00:00
  2: 09:00:00 01/11/2001
AUTO POWEROFF
  ON / OFF
```

Use the horizontal cursor buttons to select the digit to be modified.
Use the vertical cursor buttons to adjust the value.

To select the display style, use the vertical cursor buttons to select either "1" or "2".

The value selected with the vertical cursor buttons flashes.
The selected items are displayed in red.

For the auto-power off setting, use the lateral cursor buttons to select either "on" or "off". After a selection is made, the item is then displayed in red.

<Default setting>

DATE/TIME : 2001/11/01 09:00:00
DISPLAY STYLE : 1 : 2001/11/01 09:00:00

*To establish the settings, press the ESC button.

Automatic measurement

To perform automatic measurement, set the START, END, and INTERVAL of measurement time.

The measurement intervals is set to "00:00," the unit will operate normally.

■ How to set

Enter the SETTING mode with the MENU button, and select the AUTO MODE and press the ENTER button. The screen for AUTO MODE setting will be displayed.

In this screen, the conditions for auto-data recording may be set.

- | | |
|----------------------------|--|
| START: | auto-data record start time (year, month, day, hour, minute) |
| END: | auto-data record end time (year, month, day, hour, minute) |
| INTERVAL: | auto-data record intervals (hour, minute) |
| SAVE DATA: | image record condition |
| 1: ALL PICTURE: | records all images every auto-data record. |
| 2: FIRST PICTURE: | records only the image at auto-mode start |
| 3: FIRST AND LAST PICTURE: | records the images at the start and end of auto-mode |

```

SETTING(AUTO MODE)
START      : 2001/04/13 15:00
END        : 2001/04/14 17:00
INTERVAL   : XX : XX
SAVE DATA:
1: ALL PICTURE
2: FIRST PICTURE
3: FIRST AND LAST PICTURE
  
```

Use the horizontal cursor buttons to select the digit to be modified.

Use the vertical cursor buttons to adjust values.

When the auto-data record intervals is set to "00:00," automatic data recording will not be activated.

To select an option of SAVE DATA, use the vertical cursor buttons.

The selected item flash, the currently selected item is displayed in red.

To put the settings into effect, press the ESC button.

The status display is "WAIT" until the unit is ready to start measuring. The unit starts automatic measurement at the set START time. The status display become "AUTO."

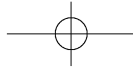

<Default settings>

START: the time when the AUTO MODE setting screen is displayed
END: the time when the AUTO MODE setting screen is displayed
INTERVAL: 00:00
Record method: 1:ALL PICTURE

*To abort running automatic measurement, press the ESC button.

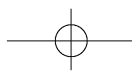
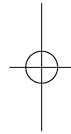
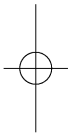

Color scale

The following three patterns may be selected for the color scale used for mosaic color display or frame color display.

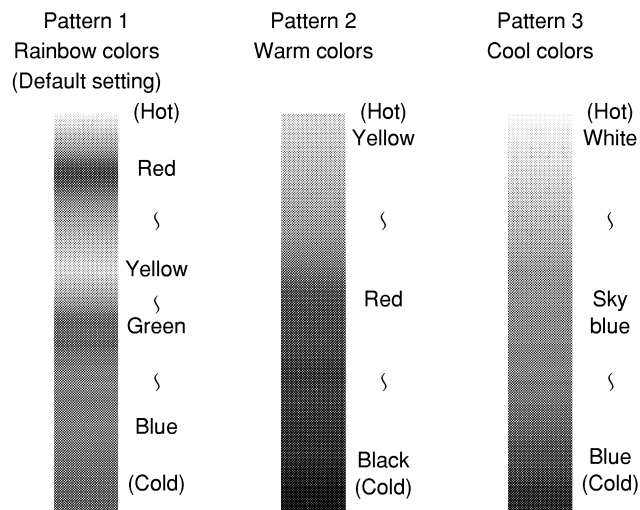

■ How to set

1. Press the MENU button to enter the SETTING mode.
2. Use the vertical cursor buttons to select COLOR SCALE and press the ENTER button. The selection screen for the temperature frame color scale will appear.
3. The horizontal cursor buttons to select patterns to be displayed.

*To establish the settings and return to the prior mode, press the ESC button.

Trouble shooting

■ The screen does not display any images.

Cause	Remedy
The batteries are exhausted.	Replace the batteries.
The backlight is OFF.	Press the LIGHT button.

■ The measured temperatures are incorrect.

Cause	Remedy
Lenses are dirty.	Clean the lenses.
There is a source of intense heat nearby.	Block or remove the source of the heat emissions from the area to be measured.
The emissivity setting is inappropriate.	Set an appropriate emissivity value.
There is little remaining power in the batteries.	Replace the batteries.
The temperature of the unit is unstable.	Let the unit get acclimatized to the surrounding temperature before measurement.

Specifications

Format	ii-1064 2D Infrared Thermometer
Measurement temperature range	-50°C to 1000°C or -58°F to 1832°F
Detector	64-element array sensor (8 horizontal rows by 8 vertical columns)
Measurement wavelength	8 μm to 16 μm
Measurement accuracy	Within $\pm 2^\circ\text{C}$ (0.0°C to 200.0°C) Within $\pm 1\%$ of the displayed value (200.1°C to 1000.0°C) Within $\pm 10\%$ of the displayed value minus 2°C (-50°C to -0.1°C)
Reproducibility	Standard mode 2σ , 64 point average Within 0.5°C (0.0°C to 500.0°C) Within 1.0°C (-50°C to -0.1°C, 500.1°C to 1000.0°C)
Image pickup element	CMOS image sensor
Liquid-crystal display	3.8 inch TFT color liquid-crystal
Shortest measurement/image distance	0.5 m
Parallax Corrector	0.5 m, 1 m, and ∞ levels
Recording medium	CF card
External connector	DC input terminal (for specially made AC adapter) Video output terminal (NTSC/PAL format)
Power source	6 "AA" alkaline or "AA" nickel-metal-hydride batteries
Surrounding temperature and humidity range for proper usage	Temperature of 0°C to 40°C Relative humidity of 35% to 85% (No condensation)
Surrounding temperature for storage	-20°C to 55°C (No condensation)
Dimensions	55 mm x 123 mm x 167 mm
Mass	Approx. 700 g (excluding batteries and CF card)

Standard accessories

- Hand strap: 1
- "AA" alkaline batteries: 6
- CF card (16 MB): 1
- Operating manual (this manual): 1

Options

- Option set (soft case, video cable, AC adapter)
- Blackbody spray
- Blackbody tape

⚠ WARNING

Using another adapter not included in the option set may result in fire or breakage. Make sure to use only the AC adapter included in the option set.

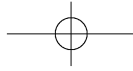

MEMO

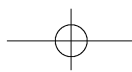
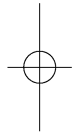
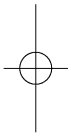

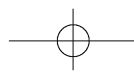
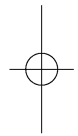
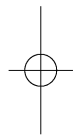
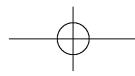



HORIBA

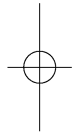

HORIBA Ltd.

Headquarters and Plant

601-8510 Kyoto, Minami-ku Kitshoin-miya-no-higashi-cho 2

Tel.: (075) 313-8121

